









Shandong Bittel Intelligent Technology Co., Ltd.
 No. 1 Rizhao North Road, Rizhao,
 Shandong, 276800, China
www.bittelgroup.com, www.hotelphone.com
info@bittelgroup.com

- Features:**
- Corded Handset with Integral DECT base station VOIP, SIP compatible.
 - Calls can be made and received from the base or the cordless handset. Up to 4 cordless handsets can be registered to each base.
 - Supports 1.8/1.9GHz, DECT6.0, WDCT standards.
 - Fast charging and low battery warning on cordless handset.
 - Mute, Flash, Speaker, Hold, Redial.
 - Redial deleted after ten minutes.
 - Adjustable earpiece / speaker volume / ringer volume.
 - Speakerphone
 - Easy web configuration
 - Desk or wall mountable.
 - Supports message waiting lamp key with retrieval function.
 - 8 Service buttons with icon.
 - Supports obtaining IP address via DHCP/Static IP.
 - Supports PCMU, G.723.1, G.729a/b, PCMA speech decoding algorithms.
 - Supports RFC2833, SIP INFO, and other DTMF transmission mode.
 - Support IEEE802.1 Q standard, IEEE802.3af protocol.
 - Support SIP protocol's standards
 - Supports upgrade through HTTP/TFTP protocol.
 - Adopts dynamic speech detection; Comfortable noise generation; Speech buffering technologies.
 - Integrated PoE power supply function for easy installation.

CONTROLS AND FUNCTIONAL KEYS

Features Description of the functional keys

-  Places the call on hold
-  Microphone switch (handset)
-  Flash button
-  MWI – Message Waiting Indicator
-  To lower or increase the speaker and handset volume
-  Redial button / Page Handset
-  For on hook dialling (speaker phone mode)
-  Key for special services
-  Key for special services

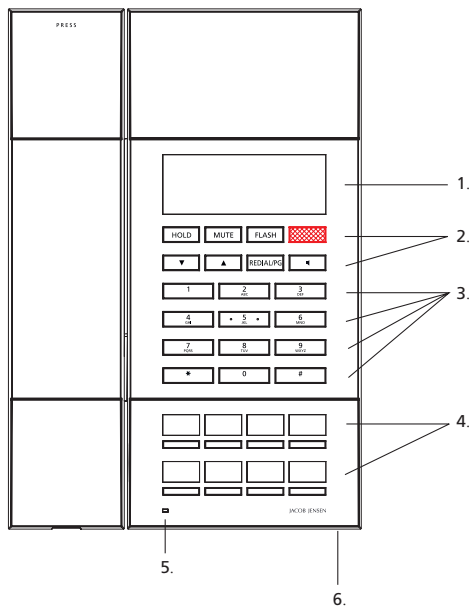

- Base unit - front**
1. Customer label area
 2. 8 functional keys
 3. 12 numerical keys
 4. Service buttons
 5. Indicator (LED) - for "Line in use (blue)" and "Mute (red)"
 6. Hands-free microphone

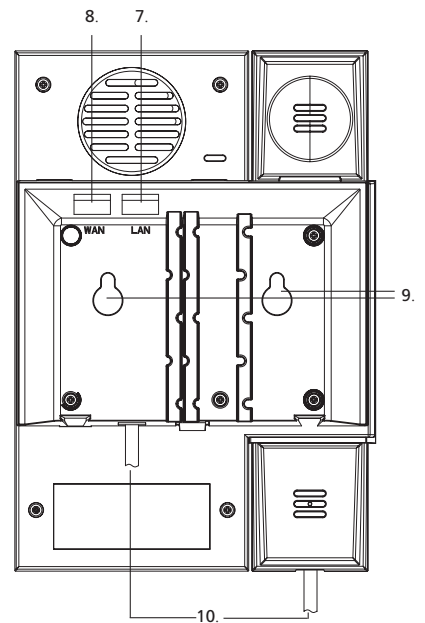

- Base unit - rear**
7. LAN port
 8. WAN port
 9. Holes for wall mounting
 10. Handset cord jack

Material:	ABS, PMMA.
Colours:	Anthracite with silver coloured plates.
Approved standards:	EN 55022 and EN 55024.